

Coil for cartridge valve

BYC03-16-01G

DC 24V
AC 220V

Other can be customized

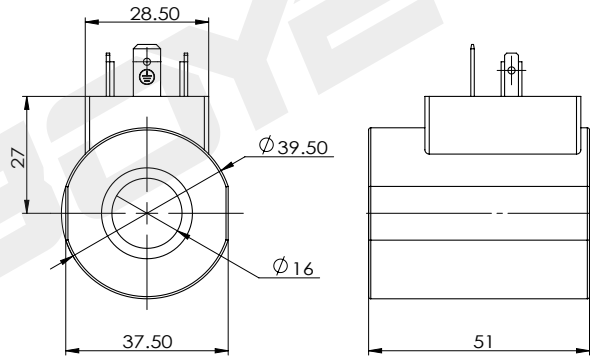

technical parameter					
Ambient temperature	°C	-25 ~ 50	Degree of protection		IP65
Voltage fluctuation range	%	85 ~ 110	Power on duration	%	100
Rated power	W	26	Insulation class		H (180)

BYC03-16-01D

DC 12V
DC 24V

Other can be customized

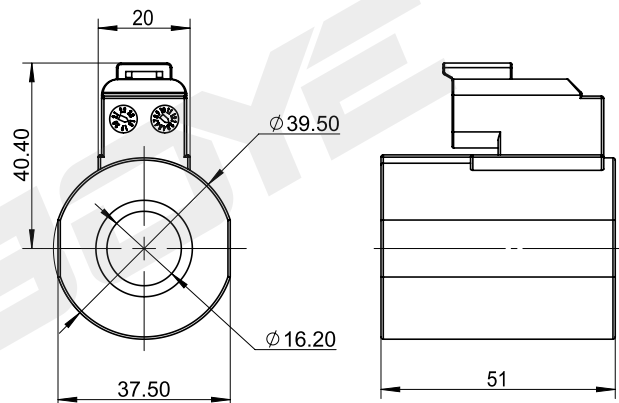
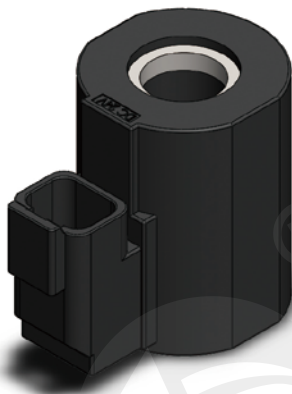

technical parameter					
Ambient temperature	°C	-25 ~ 50	Degree of protection		IP67
Voltage fluctuation range	%	85 ~ 110	Power on duration	%	100
Rated power	W	26	Insulation class		H (180)