

BYZ12-40-01A

DC solenoids for hydraulics valves

DC 24V
AC 220V

Other can be customized

- Applicable to 6-way hydraulic solenoid directional valve
- With threaded connection, the coil can be replaced without shutdown
- Equipped with manual emergency device
- Coil inner hole $\phi 20$
- Encapsulated in BMC thermosetting plastic



Outline and connection dimensions

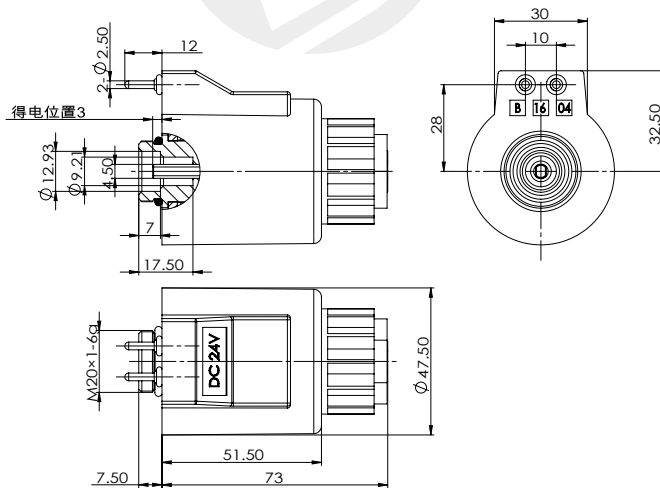

technical parameter		
Ambient temperature	°C	-25~50
Voltage fluctuation range	%	85 ~ 110
Rated power	W	30
Rated stroke	mm	3
Full stroke	mm	≥ 6.5
Working oil pressure	Mpa	≤ 21
Degree of protection		IP65
Operating frequency	T/h	12000
Power on duration	%	100
Insulation class		H(180)
Electrical connection mode		J/B

matters needing attention

1. The coil shall not be powered on alone, which has the risk of burning!
2. Non explosion-proof coil shall not be used in medium with explosion risk!
3. After the coil is installed, it must be grounded reliably, otherwise there is a risk of electric shock !

F-S characteristic curve

